

EmbeddedDNA[®]

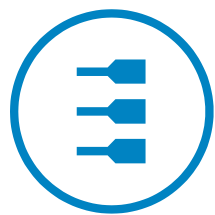
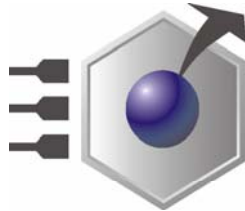

EuroTech

An0064

ACS-9075: User Manual

Rev. 1.0

Mar. 2006

COPYRIGHT 1994-2006 Eurotech S.p.A. All Rights Reserved.

ABOUT THIS MANUAL

This application note contains details of the ACS-9075 USB Adaptor range



Via J. Linussio 1
33020 AMARO (UD)
ITALY

Phone: +39 0433 485 411
Fax: +39 0433 485 499

Website: www.eurotech.it
E-mail: sales@eurotech.it



NOTICE

Although all the information contained herein has been carefully verified, Eurotech S.p.A. assumes no responsibility for errors that might appear in this document, or for damage to property or persons resulting from an improper use of this manual and of the related software. Eurotech S.p.A. reserves the right to change the contents and form of this document, as well as the features and specifications of its products at any time, without notice.

Trademarks and registered trademarks appearing in this document are the property of their respective owners

Conventions

The following table lists conventions used throughout this guide.

Icon	Notice Type	Description
	Information note	Important features or instructions
	Warning	Information to alert you to potential damage to a program, system or device or potential personal injury

(This page is intentionally left blank.)

Contents

Conventions	3
Contents	5
Chapter 1 General Overview.....	7
Product range.....	8
Package contents.....	8
Chapter 2 Components in detail	9
2-Port USB adaptor.....	10
6-Port USB adaptor.....	12
7030000245: Interface cable	14
7030000082: Interface cable	15
7030000240: Interface cable	17
7000000160: Interface cable	18
7000000155: Interface cable	19
Related Documents	20
Where to find us.....	20

(This page is intentionally left blank.)

Chapter 1 General Overview

Product range

Model Number	Description	Applies to
ACS-9075-00	2 Port USB1.0 Adaptor	CPU-1232
ACS-9075-01	1 Port USB1.0 Adaptor	CPU-1432
ACS-9075-02	4 Port USB1.1 Adaptor	CPU-1450 CPU-1453 CPU-1460 CPU-1463 CPU-1850
ACS-9075-03	6 Port USB2.0 Adaptor	CPU-1451 CPU-1461

These parts can be ordered by contacting the Eurotech sales department:

Telephone: (0039) 0433.485.411
 E-Mail: <mailto:Sales@eurotech.it>

Package contents

Package Name	Contents	Notes	Page #
ACS-9075-00	1x USB 2 Port adaptor		10
	1x 7030000245 interface cable		14
ACS-9075-01	1x USB 2 Port adaptor	Only one port is used with the CPU-1432	10
	1x 7030000082 interface cable		15
ACS-9075-02	2x USB 2 Port adaptor		10
	1x 7030000240 interface cable		17
	1x 7000000160 interface cable		18
ACS-9075-03	1x USB 6 Port adaptor		12
	1x 7000000155 interface cable		19
	1x 7000000160 interface cable		18

Chapter 2 Components in detail

This chapter gives detailed information regarding each individual component supplied.

2-Port USB adaptor

Applicable to:

CPU-1232 and CPU-1432

Please note that when used with the CPU-1432, only one port is available.

Layout:

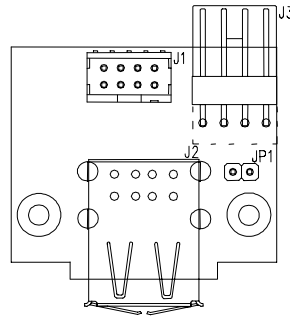

Connector Pins:



Mating face of USB type A female

Connector Description:

Connector	Use	Type	Pins	Format	Pitch
J1	CPU Interface	Minitek	8	4x2	2.00mm
J2	USB 1 (Bottom) & USB 2 (Top)	2x Female USB Type A	--	--	--
J3	Power Input	SIL Male	4	4x1	2.54mm

Connector Wiring:

Connector	Pin #	Signal
J1	1	VDD 1#
J1	2	Ground
J1	3	USB_DP1
J1	4	USB_DN1
J1	5	VDD 2#
J1	6	Ground
J1	7	USB_DP2
J1	8	USB_DN2

Connector	Pin #	Signal
J3	1	VDD
J3	2	Ground
J3	3	Ground
J3	4	Not Connected

Schematic Diagram:

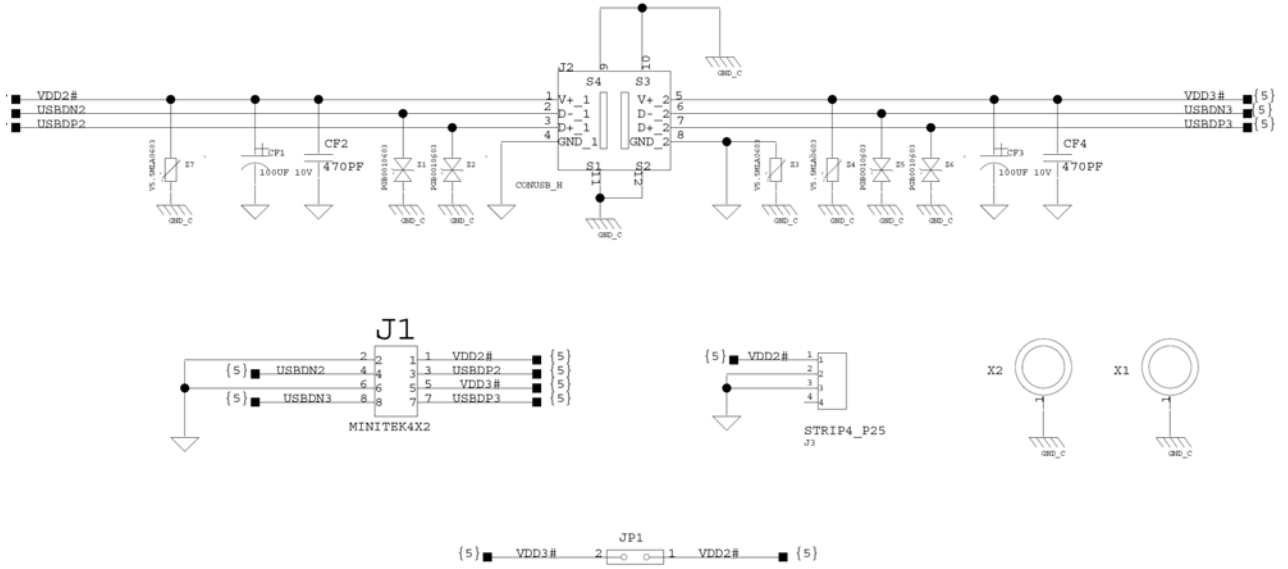

6-Port USB adaptor

Applicable to:

CPU-1450, CPU-1451, CPU-1453, CPU-1460, CPU-1461, CPU-1463 and CPU-1850

Layout:

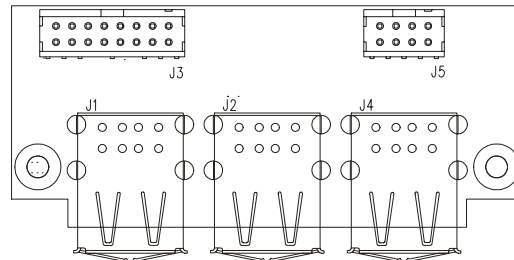

Connector Pins:



Mating face of USB type A female

Connector Description:

Connector	Use	Type	Pins	Format	Pitch
J1	USB 1 (Bottom) & USB 2 (Top)	2x Female USB Type A	--	--	--
J2	USB 3 (Bottom) & USB 4 (Top)	2x Female USB Type A	--	--	--
J3	CPU Interface USB 1, 2, 3 & 4	Minitek	16	8x2	2.00mm
J4	USB 3 (Bottom) & USB 4 (Top)	2x Female USB Type A	--	--	--
J5	CPU Interface USB 5 & 6	Minitek	8	4x2	2.00mm

Connector Wiring:

Connector	Pin #	Signal
J3	1 & 5	USB_3 & USB_4 VDD
J3	2, 6, 10 & 14	Ground
J3	3	USB_4-
J3	4	USB_4+
J3	7	USB_3-
J3	8	USB_3+
J3	9 & 13	USB_1 & USB_2 VDD
J3	11	USB_2-
J3	12	USB_2+
J3	15	USB_1-
J3	16	USB_1+

Connector	Pin #	Signal
J5	1	USB_5 VDD
J5	2, 6	Ground
J5	3	USB_5-
J5	4	USB_5+
J5	5	USB_6 VDD
J5	7	USB_6-
J5	8	USB_6+

Schematic Diagram:

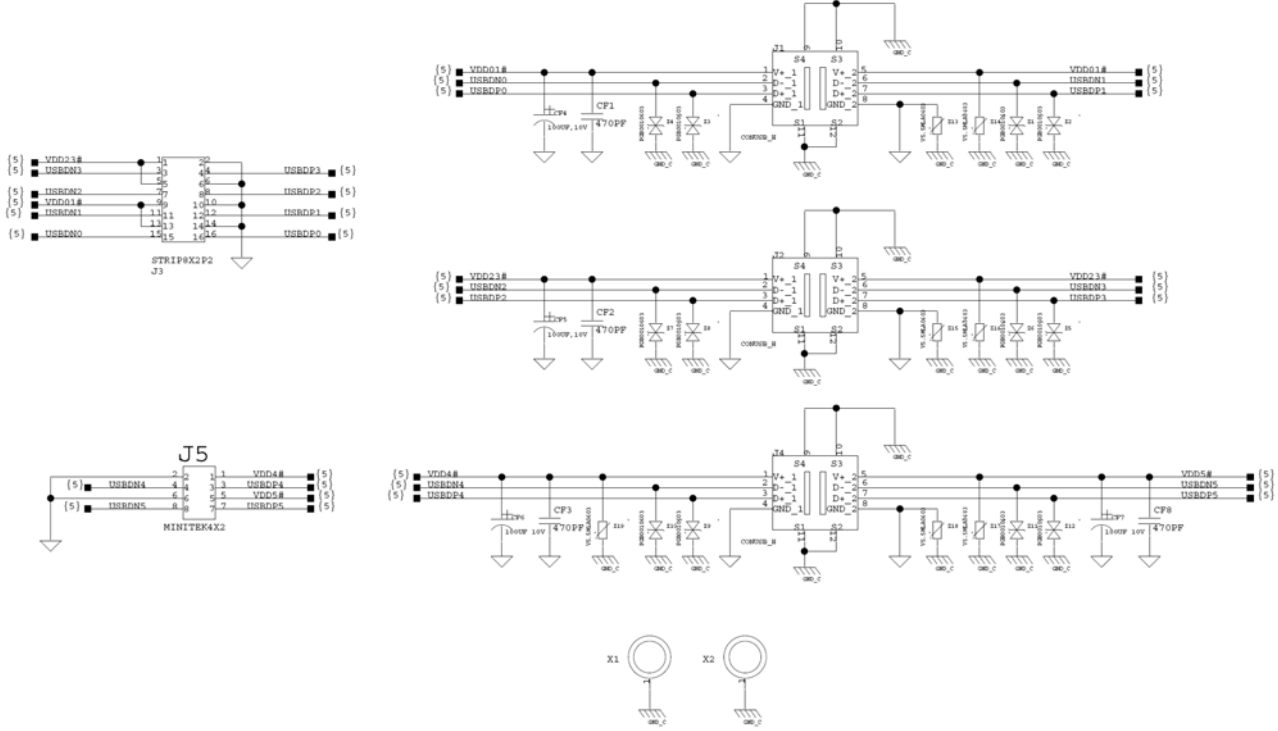

703000245: Interface cable

Applicable to:
CPU-1232

Diagram:

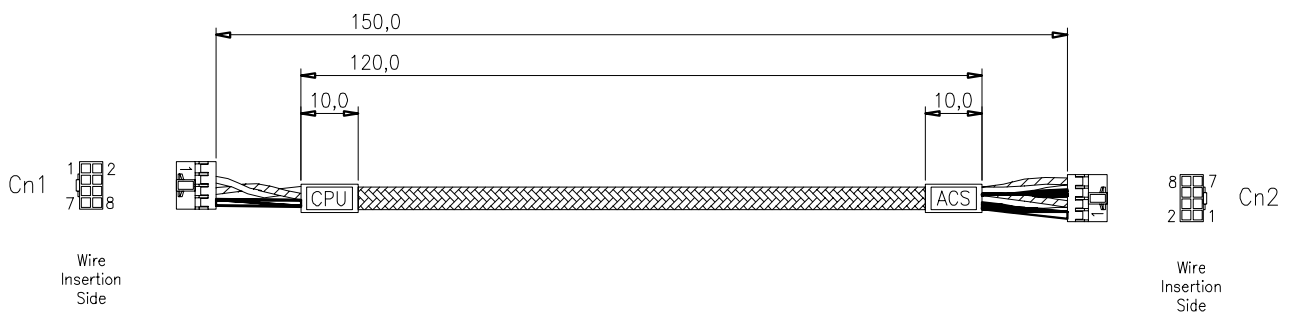

Connector Details:

Connector	Type	Pins	Format	Pitch
Cn1	Minitek	8	4x2	2.00mm
Cn2	Minitek	8	4x2	2.00mm

Wiring Information:

Connector	Pin #	To Connector	Pin #	Length Cm	Size AWG	Colour	Signal	Notes
Cn1	1	Cn2						
Cn1	2	Cn2						
Cn1	3	Cn2	4	15	28	White	USB_P0N	Twisted with USB_P0P
Cn1	4	Cn2	8	15	28	White	USB_P1N	Twisted with USB_P1P
Cn1	5	Cn2	3	15	26	Green	USB_P0P	Twisted with USB_P0N
Cn1	6	Cn2	7	15	26	Green	USB_P1P	Twisted with USB_P1N
Cn1	7	Cn2	2	15	28	Black	Ground	
Cn1	8	Cn2	6	15	28	Black	Ground	

7030000082: Interface cable

Applicable to:
CPU-1432

Diagram:

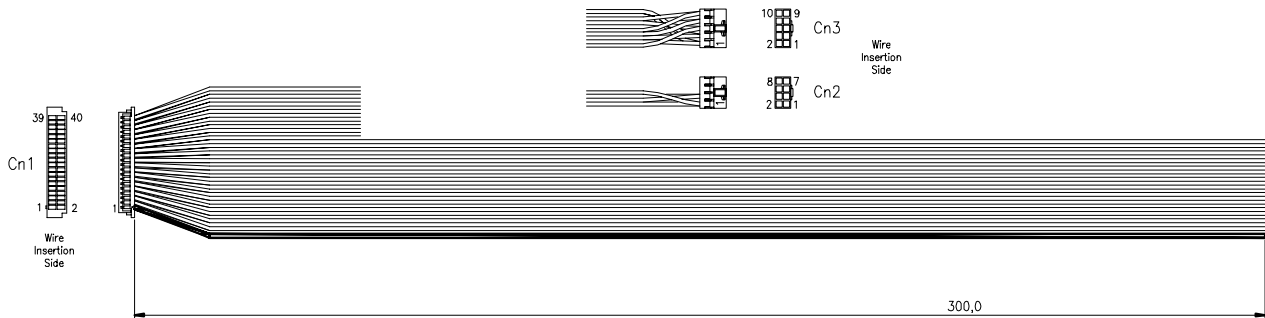

Connector Details:

Connector	Type	Pins	Format	Pitch
Cn1	Hirose	40	20x2	1.25mm
Cn2	Minitex	10	5x2	2.00mm
Cn3	Minitex	8	4x2	2.00mm

Wiring information is on the following page ...

Wiring Information:

Connector	Pin #	To Connector	Pin #	Length CM	Size AWG	Signal
Cn1	1	No Connector	--	30	28	FP GND
Cn1	2	No Connector	--	30	28	FP CLK
Cn1	3	No Connector	--	30	28	FP GND
Cn1	4	No Connector	--	30	28	FP17 R5
Cn1	5	No Connector	--	30	28	FP DISPEN
Cn1	6	No Connector	--	30	28	FP16 R4
Cn1	7	No Connector	--	30	28	FP15 R3
Cn1	8	No Connector	--	30	28	FP14 R2
Cn1	9	No Connector	--	30	28	FP13 R1
Cn1	10	No Connector	--	30	28	FP12 R0/GND
Cn1	11	No Connector	--	30	28	FP5 B5
Cn1	12	No Connector	--	30	28	FP VDDEN
Cn1	13	No Connector	--	30	28	FP4 B4
Cn1	14	No Connector	--	30	28	FP3 B3
Cn1	15	No Connector	--	30	28	FP2 B2
Cn1	16	No Connector	--	30	28	FP1 B1
Cn1	17	No Connector	--	30	28	FP0 B0/GND
Cn1	18	No Connector	--	30	28	FP11 G5
Cn1	19	No Connector	--	30	28	FP BKLEN
Cn1	20	No Connector	--	30	28	FP10 G4
Cn1	21	No Connector	--	30	28	FP9 G3
Cn1	22	No Connector	--	30	28	FP8 G2
Cn1	23	No Connector	--	30	28	FP7 G1
Cn1	24	No Connector	--	30	28	FP6 G0/GND
Cn1	25	No Connector	--	30	28	FP VSYNC
Cn1	26	No Connector	--	30	28	FP HSYNC
Cn1	27	Cn2	2	30	28	USB GND
Cn1	28	Cn2	3	30	28	USB DP
Cn1	29	Cn2	4	30	28	USB DN
Cn1	30	Cn2	1	30	28	USB VDD
Cn1	31	Cn3	5	30	28	PC BEEP
Cn1	32	Cn3	1	30	28	AC97 CDD
Cn1	33	Cn3	3	30	28	SDATA OUT
Cn1	34	Cn3	7	30	28	RST DRV
Cn1	35	Cn3	9	30	28	SDATA IN
Cn1	36	Cn3	8	30	28	SYNC
Cn1	37	Cn3	6	30	28	AC97 GND
Cn1	38	Cn3	10	30	28	AC97 CLK
Cn1	39	Cn3	2	30	28	AC97 GND
Cn1	40	Cn3	4	30	28	BIT CLK

703000240: Interface cable

Applicable to:

CPU-1450, CPU-1453, CPU-1460, CPU-1463 and CPU-1850

Diagram:

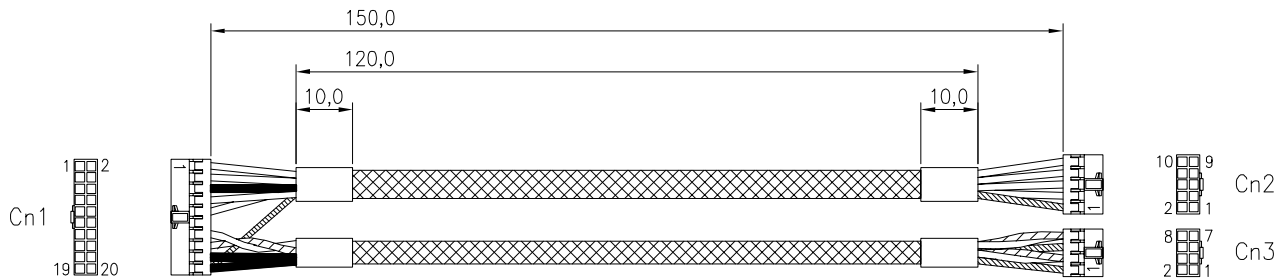

Connector Details:

Connector	Type	Pins	Format	Pitch
Cn1	Minitek	20	10x2	2.00mm
Cn2	Minitek	10	5x2	2.00mm
Cn3	Minitek	8	4x2	2.00mm

Wiring Information:

Connector	Pin #	To Connector	Pin #	Length Cm	Size AWG	Colour	Signal	Notes
Cn1	1	Cn2	5	15	28	Grey	SPKR	
Cn1	2	NC	--	--	--	--	SDIN1	
Cn1	3	Cn2	3	15	28	Grey	SDOUT	
Cn1	4	NC	--	--	--	--	CDC_EN#	
Cn1	5	Cn2	2	15	26	Black	Ground	
Cn1	6	Cn2	6	15	26	Black	Ground	
Cn1	7	Cn2	9	15	28	Grey	SDIN0	
Cn1	8	Cn2	4	15	28	Grey	BITCLK	
Cn1	9	Cn2	7	15	28	Grey	RST	
Cn1	10	Cn2	8	15	28	Grey	SYNC	
Cn1	11	NC	--	--	--	--	Ground	
Cn1	12	NC	--	--	--	--	USB_OC1#	
Cn1	13	Cn3	4	15	28	White	USB_P0N	Twisted with USB_P0P
Cn1	14	Cn3	8	15	28	White	USB_P1N	Twisted with USB_P1P
Cn1	15	Cn3	3	15	28	Green	USB_P0P	Twisted with USB_P0N
Cn1	16	Cn3	7	15	28	Green	USB_P1P	Twisted with USB_P1N
Cn1	17	Cn3	2	15	26	Black	Ground	
Cn1	18	Cn3	1, 5	15	26	Red	+5V	Double wire
Cn1	19	Cn3	6	15	26	Black	Ground	
Cn1	20	Cn2	1	15	26	Red	+5V	

7000000160: Interface cable

Applicable to:

CPU-1450, CPU-1451, CPU-1453, CPU-1460, CPU-1461, CPU-1463 and CPU-1850

Diagram:

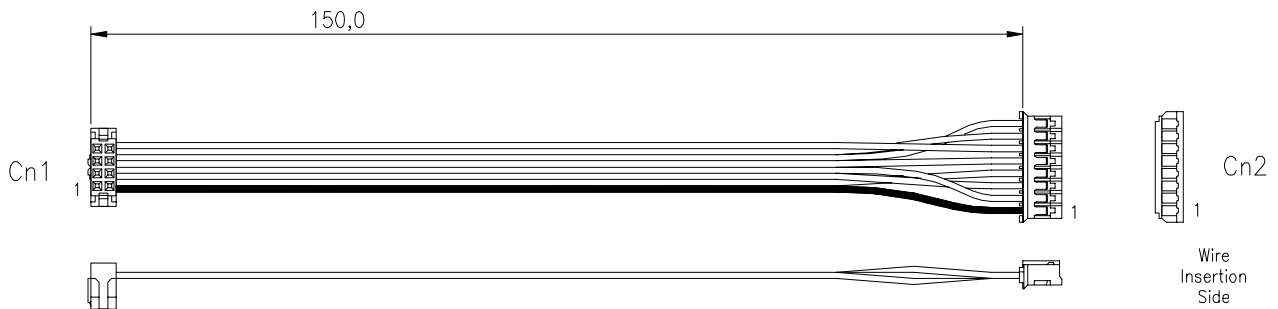

Connector Details:

Connector	Type	Pins	Format	Pitch
Cn1	Minitek IDC	8	4x2	2.00mm
Cn2	JST PH	8	4x2	2.00mm

Wiring Information:

Connector	Pin #	To Connector	Pin #	Length Cm	Size AWG	Signal	Notes
Cn1	1	Cn2	1	15	28	+5V	
Cn1	2	Cn2	4	15	28	Ground	
Cn1	3	Cn2	3	15	28	USB_P0P	Twisted with USB_P0N
Cn1	4	Cn2	2	15	28	USB_P0N	Twisted with USB_P0P
Cn1	5	Cn2	5	15	28	+5V	
Cn1	6	Cn2	8	15	28	Ground	
Cn1	7	Cn2	7	15	28	USB_P1P	Twisted with USB_P1N
Cn1	8	Cn2	6	15	28	USB_P1N	Twisted with USB_P1P

700000155: Interface cable

Applicable to:
CPU-1451 and CPU-1461

Diagram:

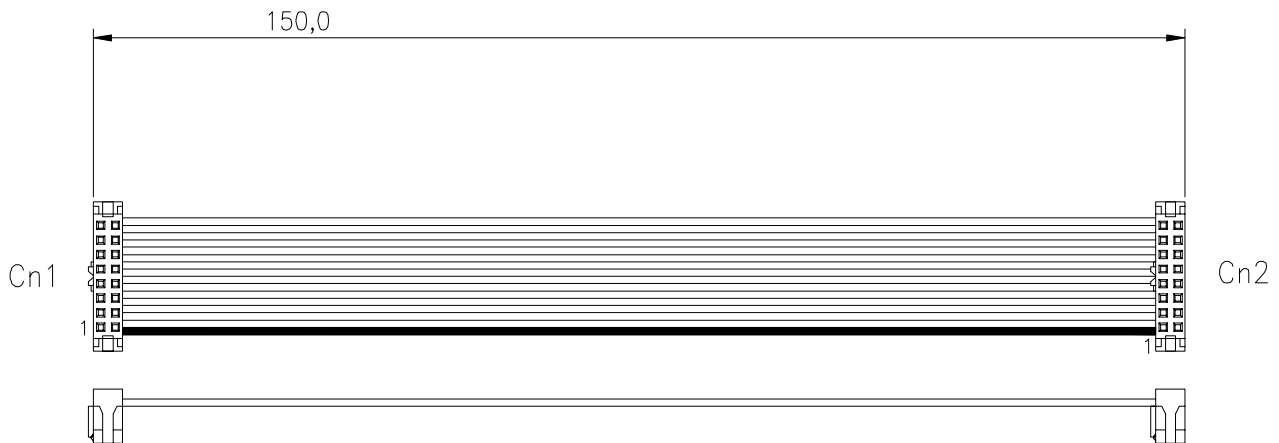

Connector Details:

Connector	Type	Pins	Format	Pitch
Cn1	Minitek IDC	16	8x2	2.00mm
Cn2	Minitek IDC	16	8x2	2.00mm

Wiring Information:

Connector	Pin #	To Connector	Pin #	Length Cm	Size AWG	Signal
Cn1	1	Cn2	1	15	28	VDD
Cn1	2	Cn2	2	15	28	Ground
Cn1	3	Cn2	3	15	28	USB_4-
Cn1	4	Cn2	4	15	28	USB_4+
Cn1	5	Cn2	5	15	28	VDD_USB_3,4
Cn1	6	Cn2	6	15	28	Ground
Cn1	7	Cn2	7	15	28	USB_3-
Cn1	8	Cn2	8	15	28	USB_3+
Cn1	9	Cn2	9	15	28	VDD
Cn1	10	Cn2	10	15	28	Ground
Cn1	11	Cn2	11	15	28	USB_2-
Cn1	12	Cn2	12	15	28	USB_2+
Cn1	13	Cn2	13	15	28	VDD
Cn1	14	Cn2	14	15	28	Ground
Cn1	15	Cn2	15	15	28	USB_1-
Cn1	16	Cn2	16	15	28	USB_1+

Related Documents

For further information refer to the User Manual for the CPU that the adaptor is intended to be used with.

Where to find us

Eurotech S.p.A.

Via Jacopo Linussio, 1 - 33020 Amaro (UD) ITALY

Tel. +39 0433 485411

Fax +39 0433 485499

Welcome@eurotech.it

www.eurotech.it