

ACS-9095-05

10/100MB Ethernet Adaptor for Eurotech CPU Modules

General Features

- The ACS-9095-05 is an adapter kit that has been developed by Eurotech to simplify the Ethernet connection with Eurotech CPU modules
- Termination Jumpers for maximum compatibility
- LED indicators for Connection and Activity
- RoHS Compliant

Kit Contents

- 1x ACS-9095 10/100MB Ethernet adaptor
- 1x 7000000091L interface cable
- 1x 7030000163L interface cable

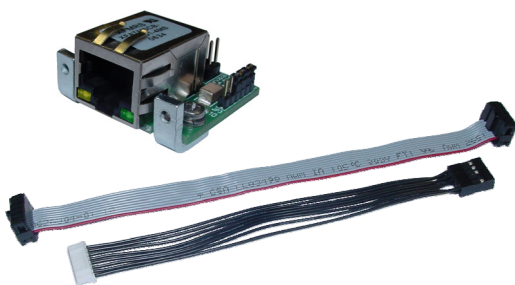

Related Parts

ACS-9095-07:

- 2nd 10/100MB Ethernet adaptor for the CPU-1421

Ethernet Adaptor Layout

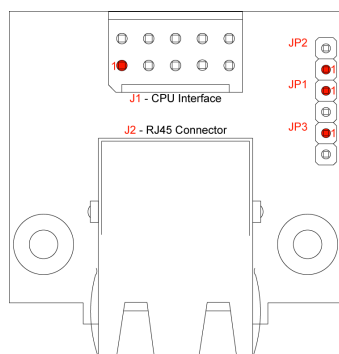

Jumper Details

- JP1, JP2 & JP3: Termination Selection
- Type: 2-pin, 2.00mm pitch

JP1	JP2	JP3	Definition	Default
Open	Open	Open	Intel 82562ET CPU-145x CPU-146x CPU-147x CPU-148x Intel 82551IT ISIS	
Closed	Closed	Open	Realtek 8139D & 8139DL CPU-1433 CPU-1233	
Closed	Closed	Closed	Realtek 8019AS & 8139C CPU-1421	✓

Connector Details

J1: Computer Interface

- Type: Male Minitek™ , 10-pin (5x2), 2.54 mm pitch

Pin #	Use	Pin #	Use
1	Vcc	2	Activity LED
3	+ Receive Data	4	- Receive Data
5	Link LED	6	Ground
7	Not Connected	8	Ground
9	+ Transmit Data	10	- Transmit Data

Mechanical Dimensions

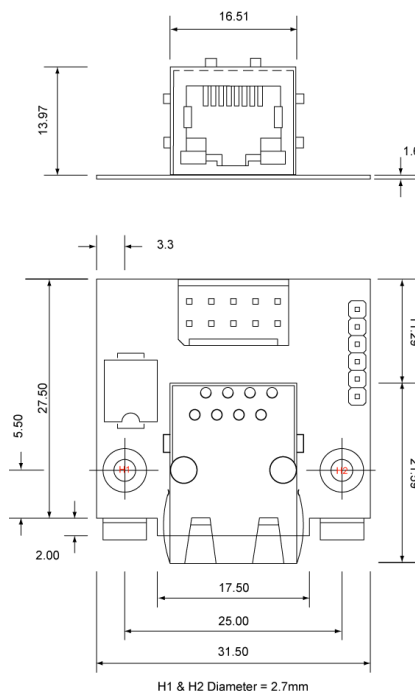

ACS-9095-05

Mechanical Dimensions (Continued)

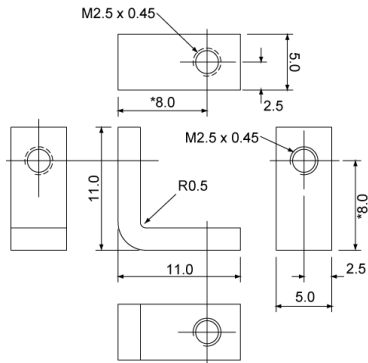

Mounting bracket dimensions (mm)

Schematics

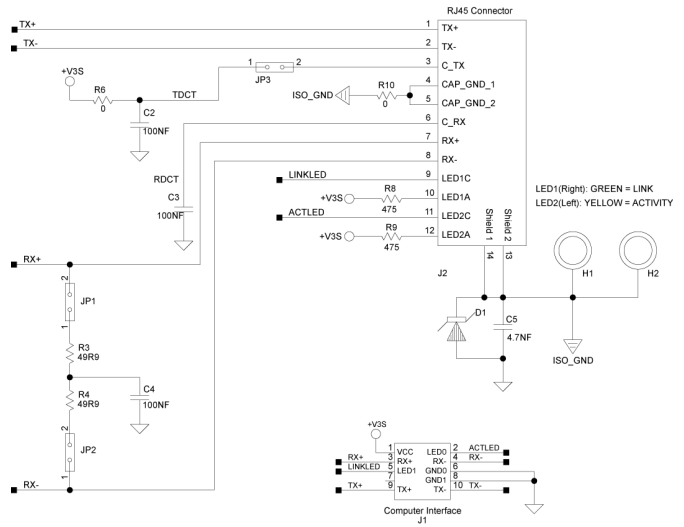

700000091L

Module	CPU Connector
CPU-1233	J18
CPU-1421	J12

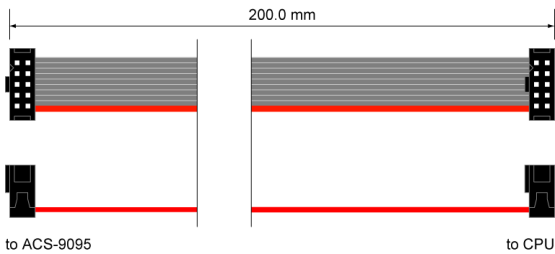

Connector Details

- Type: female Minitex™, 10-pin (5x2), 2.54 mm pitch

From CPU	To ACS-9095	From CPU	To ACS-9095
1	1	2	2
3	3	4	4
5	5	6	6
7	7	8	8
9	9	10	10

7030000163L

Module	CPU Connector
CPU-1433	J16
CPU-145x	J20
CPU-146x	J20
CPU-147x	J20
CPU-148x	J20
ISIS	J20

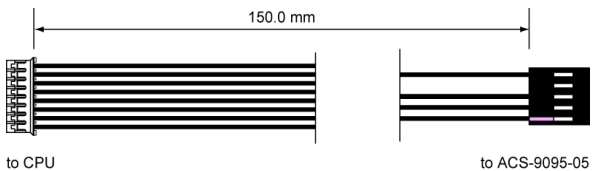

Connector Details

- 1x Female JST PH, 8pin (8x1), 2.00mm pitch
- 1x Female Minitex, 10pin (5x2), 2.54mm pitch

From CPU	To ACS-9095	From CPU	To ACS-9095
1	10	2	9
3	6	4	5
5	4	6	3
7	2	8	1
1	10	2	9

ACS-9095-05_Td0004_Rev 1.2

Americas

EUROTECH Inc
e-mail: sales-us@eurotech.com
tel: +1 301.490.4007
toll free: +1 888.941.2224

Western Europe

EUROTECH UK
e-mail: sales-uk@eurotech.com
tel: +44 (0) 1223 403.410

Central & Southern Europe

EUROTECH Italy
e-mail: sales-it@eurotech.com
tel: +39 0433.485.411

Northern & Eastern Europe

EUROTECH Finland
e-mail: sales-fi@eurotech.com
tel: +358 9.477.888.0