

ACS-9092-00

Two 2-port USB Adaptors

General Features

- The ACS-9092-00 is an adapter kit that has been developed by Eurotech to simplify the interfacing of USB peripherals with Eurotech CPU modules
- For use with: CPU-1233, CPU-1433, CPU-145x, CPU-146x, CPU-147x, CPU-148x and ISIS
- RoHS Compliant

Kit Contents

- 2x 9C220600S1L: 2-Port USB adaptors

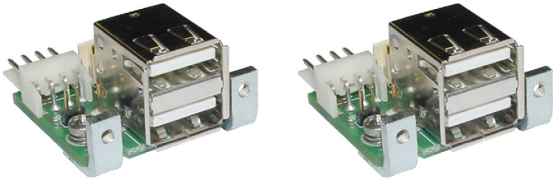

- 1x 7000000160L interface cable



- 1x 7030000245L interface cable



- 1x 7030000240L interface cable



Related Parts

ACS-9092-02:

- Two 2-Port USB adaptors for use with: CPU-1452, CPU-1462, CPU-1472, CPU-1482 and ISIS.

9C220600S1L Layout

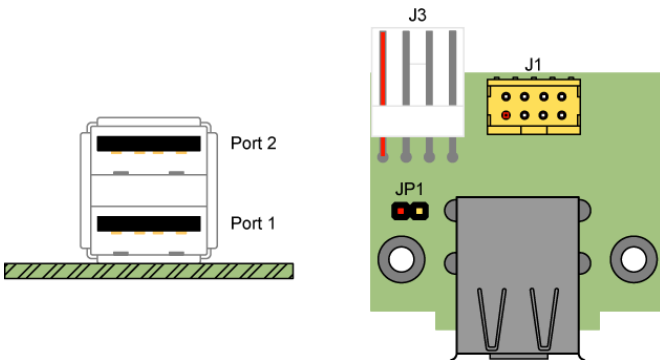

9C220600S1L Jumper Details

- JP1: External Power Routing
- Type: 2-pin, 2.00mm pitch

JP1	Definition
Open	Only Port 1 receives external power from J3
Closed	Port 1 and Port 2 receive external power from J3

9C220600S1L Connector Details

J1: Computer Interface

- Type: Male Minitek™ Shrouded Header, 8-pin, 2.00 mm pitch

Pin #	Port #	Use	Pin #	Port #	Use
1	1	VDD 1	2	1	Ground
3	1	+ Data	4	1	- Data
5	2	VDD 2	6	2	Ground
7	2	+ Data	8	2	- Data

J3: External Power Input

- Type: Male 4-pin 2.54mm pitch

Pin #	Use
1	VDD 1
2	Ground
3	Ground
4	Not Connected

9C220600S1L Mechanical Dimensions

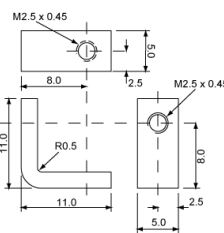
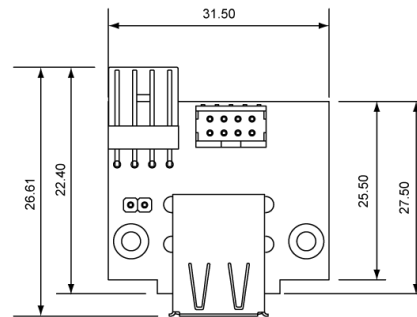

1100000110L Mounting Brackets

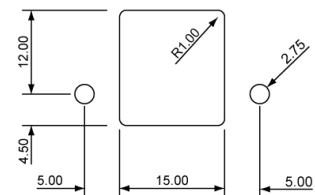

Front Mounting locations when using 1100000110L

All dimensions in millimeters

ACS-9092-00

9C220600S1L Schematics

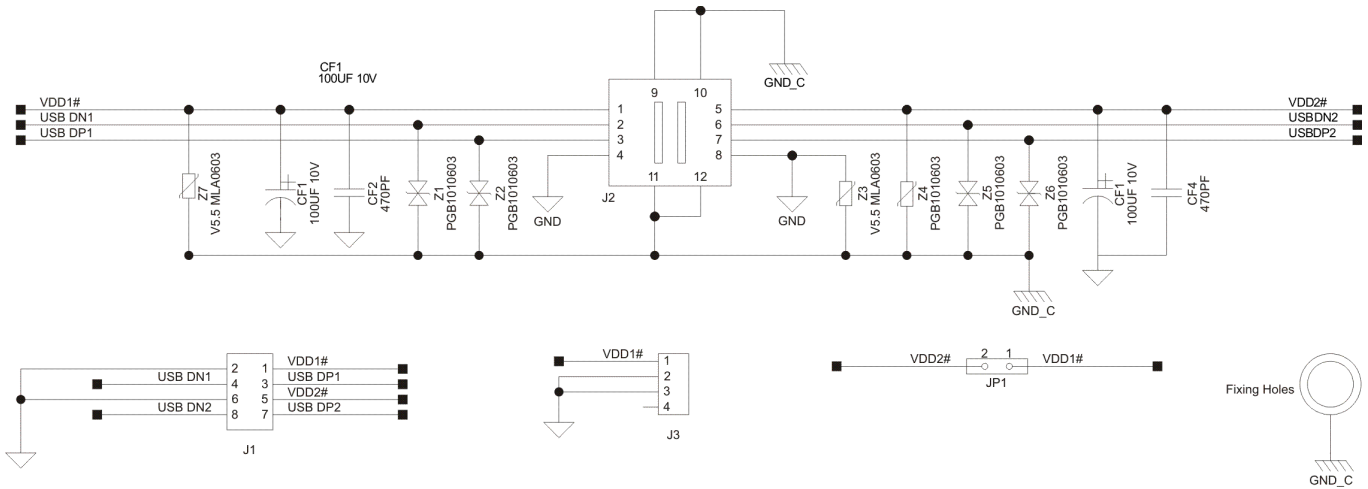

700000160L

Module	CPU Connector	Module	CPU Connector
CPU-1233	J21	CPU-147x	J7
CPU-1433	J17	CPU-148x	J7
CPU-145x	J7	ISIS	J7
CPU-146x	J7		

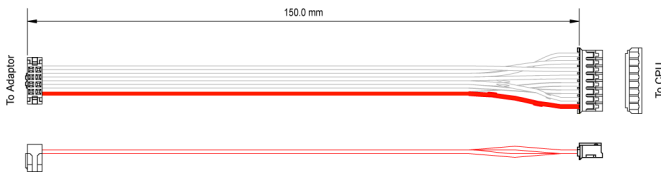

Connector Details

- 1x Female Minitek IDC, 8pin (4x2), 2.00mm pitch
- 1x Female JST PH SIL, 8pin (8x1), 2.00mm pitch

From ACS-9092	To CPU	From ACS-9092	To CPU
1	1	2	4
3	3	4	2
5	5	6	6
7	7	8	6

703000245L

Module	CPU Connector
CPU-1233	J7

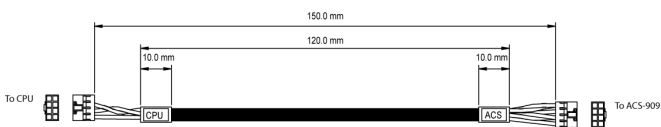

Connector Details

- 2x Female Minitek, 8pin (4x2), 2.00mm pitch

To CPU	To ACS-9092	To CPU	To ACS-9092
1	Not Connected	2	Not Connected
3	4	4	8
5	3	6	7
7	2	8	6

703000240L

Module	CPU Connector	Module	CPU Connector
CPU-1433	J6	CPU-147x	J14
CPU-145x	J14	CPU-148x	J14
CPU-146x	J14		

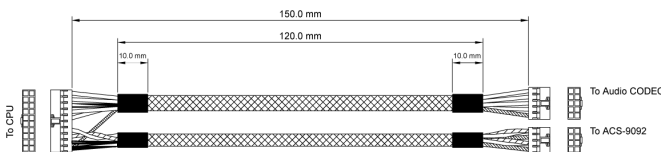

Connector Details

Note: Pins 1~12 & 20 are used for the ACS-9093 Audio CODEC and are not shown in the following table.

- 1x Female Minitek, 20pin (10x2), 2.00mm pitch
- 1x Female Minitek, 10pin (5x2), 2.00mm pitch
- 1x Female Minitek, 8pin (4x2), 2.00mm pitch

To CPU	To ACS-9092	To CPU	To ACS-9092
13	4	14	8
15	3	16	7
17	2	18	1 & 5
19	6		

ACS-9092-00_Td0001_Rev 1.2

Americas

EUROTECH Inc
e-mail: sales-us@eurotech.com
tel: +1 301.490.4007
toll free: +1 888.941.2224

Western Europe

EUROTECH UK
e-mail: sales-uk@eurotech.com
tel: +44 (0) 1223 403.410

Central & Southern Europe

EUROTECH France
e-mail: sales-fr@eurotech.com
tel: +33 04.72.89.00.90

EUROTECH Italy

e-mail: sales-it@eurotech.com
tel: +39 0433.485.411

Northern & Eastern Europe

EUROTECH Finland
e-mail: sales-fi@eurotech.com
tel: +358 9.477.888.0