

EmbeddedDNA[®]

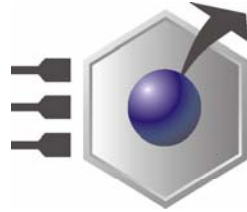

EuroTech
THE COMPLETE EMBEDDED PC SOLUTION

An0038

CPU-1220; Ethernet Aapter

Rev. 1.0

Apr 2004

COPYRIGHT 1994-2005 Eurotech S.p.A. All Rights Reserved.

ABOUT THIS MANUAL

This application note is intended to help users detecting which Ethernet interface is installed over the CPU-1220.



Via J. Linussio 1
33020 AMARO (UD)
ITALY

Phone: +39 0433 485 411
Fax: +39 0433 485 499

web: <http://www.eurotech.it>
e-mail: <mailto:sales@eurotech.it>



NOTICE

Although all the information contained herein has been carefully verified, Eurotech S.p.A. assumes no responsibility for errors that might appear in this document, or for damage to property or persons resulting from an improper use of this manual and of the related software. Eurotech S.p.A. reserves the right to change the contents and form of this document, as well as the features and specifications of its products at any time, without notice.

Trademarks and registered trademarks appearing in this document are the property of their respective owners

Conventions

The following table lists conventions used throughout this guide.

Icon	Notice Type	Description
	Information note	Important features or instructions
	Warning	Information to alert you to potential damage to a program, system or device or potential personal injury

(This page is intentionally left blank.)

Contents

Conventions	3
Contents	5
Chapter 1 CPU-1220 Ethernet interface	7
Detecting the Realtek chipset version installed into your CPU-1220	7
Ethernet interface.....	8
<i>J4: CPU-1220 Ethernet connector</i>	8
<i>J9: Status LEDs</i>	9
Ethernet physical adapter	9
Related Documents	13

(This page is intentionally left blank.)

Chapter 1 CPU-1220 Ethernet interface

The CPU-1220 Ethernet interface features a single-chip Fast Ethernet controller Realtek RTL8139 that provides 32-bit performance, 10/100Mbps auto-sensing, and full compliance with IEEE 802.3u 100Base-T specifications and IEEE 802.3x Full Duplex Flow Control.

The versions of the Relatek RTL8139 chipset installable over the CPU-1220 board are:

- RTL8139 B
- RTL8139 C

Between the two devices there are only different electrical characteristics. It is important to know which version of RTL8139 is installed on the board to select the proper Ethernet physical adapter and to connect or to develop custom circuitry.

Detecting the Realtek chipset version installed into your CPU-1220

To detect which version of Realtek chipset is installed on the CPU-1220, read the printed label on the Realtek RTL8139 chip.

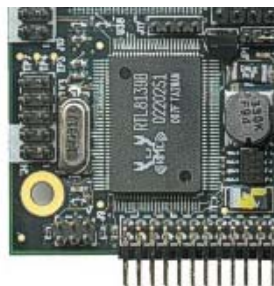

Figure 1. The Realtek RTL8139 chip

Comparing the CPU-1220 serial number¹ with the following table is possible to detect the installed chipset version:

Table 1. CPU-1220 RTL8139 chipset version

CPU-1220 Eurotech s/n	Realtek RTL8139 version
Till S.N. 229904389	B
Starting from 03M241 S.N. 229904390	C

Ethernet interface

The CPU-1220 module provides the following interfaces:

- J4 for a 10/100 Ethernet (LAN) connection. J4 is a 5x2 pin – 2.54mm step connector
- J9 for status LEDs: one for the HDD status, three for the Ethernet status. J9 is a 3x2 pin - 2mm step connector

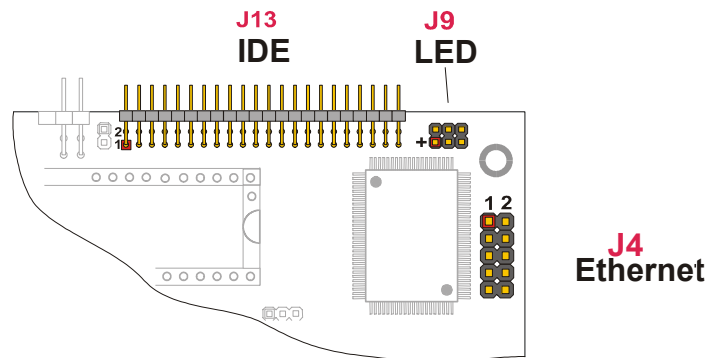

Figure 2. J13 IDE Connector layout

J4: CPU-1220 Ethernet connector

The J4 Ethernet connector is a 5x2 pin with 2.54-mm step. Refer to the following table for the Ethernet connector assignment.

Table 2. J4 Ethernet Connector

Pin#	Signal	Function
1	+5V or +3,3V ²	Power Supply
2	LED0	On sending packets
3	RX+	100/10Base-T receive data
4	RX-	100/10Base-T receive data
5	LED1	Link 10/100

¹ The Serial number of the CPU-1220 board is a bar code label printed on the PC/104 connector and consists of a 10 characters length code.

² Depending on the Realtek chipset installed: if Realtek RTL8139B is installed power supply is +5V, if RTL8139C is installed +3,3V supplied. For detailed electrical information please refer to the chipset datasheet.

6	GND	Ground signal
7	LED2	On receiving packets
8	GND	Ground signal
9	TX+	100/10Base-T transmit data
10	TX-	100/10Base-T transmit data

J9: Status LEDs

The HDD and Ethernet activity LEDs are implemented on the J9 connector. It is a 3x2 pin - 2mm step. The following table shows the J9 connector pinout:

Table 3. J9 LED Connector

Pin	Signal	Function
1	VDD	IDE LED anode
2	IDE LED	IDE LED cathode
3	5V_LAN	LAN LEDs common anode
4	LAN LED 2	LAN LED cathode
5	LAN LED 0	LAN LED cathode
6	LAN LED 1	LAN LED cathode

The meaning of LAN LEDs is the following:

- LAN LED 0: TX
- LAN LED 1: Link 10/100 (LAN LED 1 signals that the correct connection is established)
- LAN LED 2: RX

Ethernet physical adapter



Note: To establish a connection to the Ethernet, the Eurotech Ethernet Adapter can be plugged between the CPU board (to the J4 connector) and the net cable.

It is shown below.

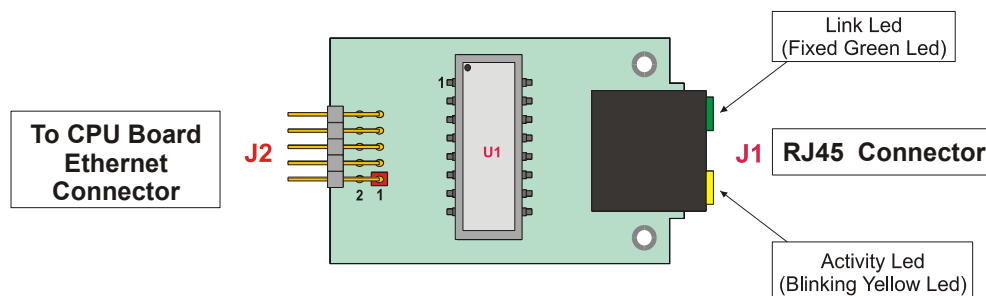

Figure 3. Eurotech Ethernet Adapter

The green led is fixed, and signals the correct connection of the module. The yellow led blinks when there is activity (data IN/OUT) on the net connection.

With RJ45 connectors, only twisted pair cables can be used.



Important Note. Connection to a 100BASE-TX hub for 100 Mbps operation requires Cat. 5 Unshielded Twisted-Pair (UTP) cable or Cat. 5 Shielded Twisted-Pair (STP) cable. The maximum length between the 100BASE-TX hub and the adapter is 100 meters. Connection to a 10BASE-T hub for 10 Mbps operation requires a Cat. 3, 4, 5 UTP cable or Cat. 5 STP cable. Preferred maximum cable length between CPU-1220 module and Ethernet adapter is 10 cm (4")

Ethernet physical adapter Versions

This physical adapter is available in two different versions:

Table 4. Physical Adapter code

EurotechCODE	Description	Valid for RTL8139
ACS-9071-00	RJ45 ETHERNET ADAPTER FOR CPU-1220 AND CPU-1231	B
ACS-9071-03	RJ45 Ethernet adapter for CPU-1232 and CPU-1220	C



Warning: To prevent incorrect data transmissions select the proper physical adapter device depending on the Realtek RTL8139 chipset installed on the CPU-1220.

Integration of the Ethernet physical adapter

If the Ethernet physical adapter has to be integrated over a custom circuitry, please refer to Eurotech for detailed information about schematics.

Regarding schematics, a good choice is isolating the Ethernet adapter section from the rest of the power supply section. Derive the supply directly from the J4 Ethernet Connector of the CPU-1220. In this way if different versions of Realtek RTL8139 chipsets are installed no damage occurs when you connect J4 to the carrier board.



Warning: please take care on the Realtek RTL8139 version used in order to avoid short-circuits between +5V and +3.3V when deriving power supply.

Generic Ethernet adapter

Eurotech has developed a fail-safe circuitry that can be installed to prevent faulty and damages. To prevent wrong connections between the CPU-1220 and the Ethernet adapter Eurotech has developed a generic adapter that can be used together with the CPU-1220 for installing both the Realtek chips.

The following drawing describes the solution for a generic Ethernet adapter tolerant regarding the supply voltage present on pin 1 of J4 CPU-1220 Ethernet connector and based on the version of the Realtek RTL8139 chipset installed, and that may be integrated into a carrier board.

Figure 4. Generic Ethernet Adapter Schematics

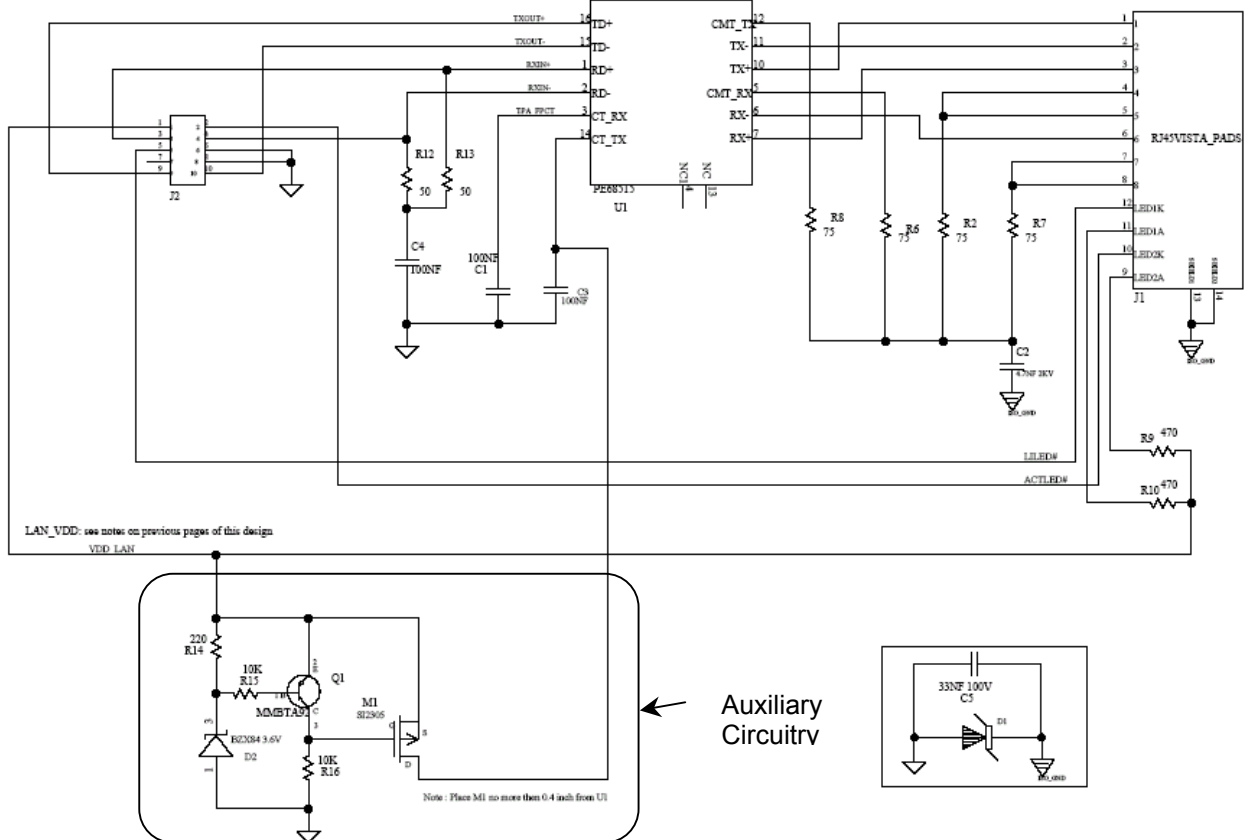

For detailed information regarding the Ethernet Adapter please contact Eurotech.

Chapter 2 Drivers

Visit the Eurotech web site for the latest driver availability.

Related Documents

For detailed information on the CPU-1220 board please refer to the User Manual.
For further information about the *Realtek RTL8139X* please refer to the *technical Data Sheet*.